



BRAKE DISC

09.7395.10

The **09.7395.10** brake disc is synonymous with reliability

The Brembo brake disc is fully interchangeable with an Original Equipment brake disc. The control of the entire production cycle allows Brembo to offer brake discs with outstanding performance levels, reliability, durability and comfort in all conditions of use. All Brembo brake discs are accompanied by the ECE-R90 homologation.

- ✓ OE-equivalent
- ✓ Brembo quality
- ✓ ECE-R90 certificate
- ✓ Safety



Technical specifications



EAN code
8020584739518

Axle
Front

Diameter Ø
260 mm

Thickness (TH)
25 mm

Height (A)
49 mm

Number of holes (C)
5

Brake disc type
Ventilated

Centering (B)
55 mm

Min. thickness
23 mm

Tightening torque
103 Nm

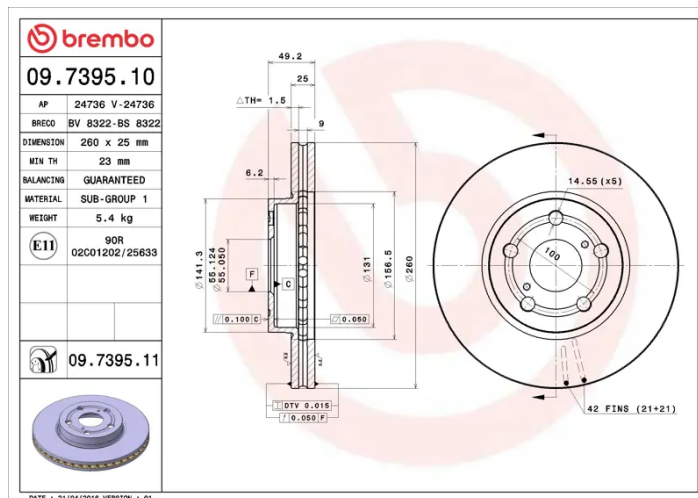

COMPATIBLE VEHICLES

COMPATIBLE OE PART NUMBERS

4351205030

TOYOTA