



SPORT | TY3 BRAKE DISC

59.E114.72

The 59.E114.72 brake disc is synonymous with reliability

Type-3 slotting used to distinguish the Brembo SPORT | TY3 brake disc is widely used in professional motorsports. It therefore offers superior initial response with excellent release characteristics, improving braking performance while giving the vehicle an aggressive appearance. The Brembo logo on the braking surface adds an exclusive and unique touch to the vehicle. The SPORT | TY3 brake discs are plug-and-play since they replace OE discs directly.

- ✓ OE-equivalent
- ✓ Brembo quality
- ✓ ECE-R90 certificate
- ✓ Safety
- ✓ Performance
- ✓ Comfort
- ✓ Sports driving
- ✓ Sparty look



Technical specifications



Diameter	Thickness (TH)	Height (A)
320 mm	20 mm	78 mm
Number of holes (C)	Brake disc type	Centering
5	Solid	75 mm
Min. thickness	Tightening torque	Axle
18,4 mm	140 Nm	Rear
Units per box	EAN code	
1	8020584605455	

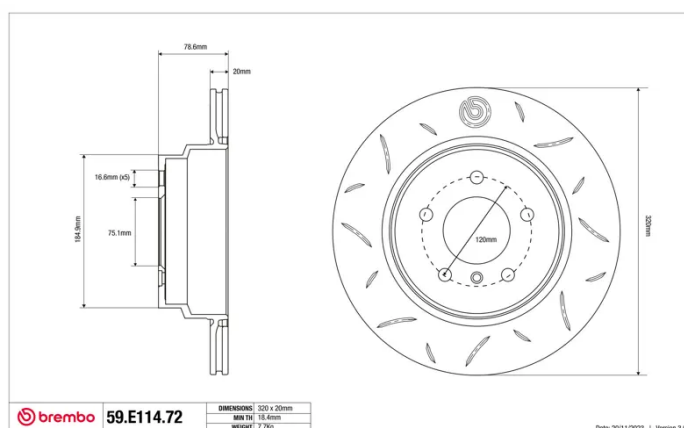

59.E114.72	DIMENSIONI: 320 x 20mm
	MIN TH: 18,4mm
	WEIGHT: 7,7kg

Date: 2011/2023 | Version: 3.00

