



BRAKE PAD PRIME CERAMIC P79020N

The P79020N NAO brake pad is synonymous with reliability

Brembo NAO brake pads stand out for their ultimate braking comfort, reduced friction wear and low dust mission, which makes for cleaner rims and reduced maintenance requirements. The advanced friction material in keeping with the strictest environmental standards is the main distinguishing feature of NAO compounds.

- ✓ OE-equivalent
- ✓ Brembo quality
- ✓ Safety
- ✓ Comfort
- ✓ Durability
- ✓ Dust reduction
- ✓ With accessories



Technical specifications

EAN code 8020584086278	Axle Front	Thickness 17 mm
Width 109 mm	Height 45 mm	Braking system Sumitomo
Wear indicator Acoustic	WVA number 23507,23508	Accessories With anti-squeal shim

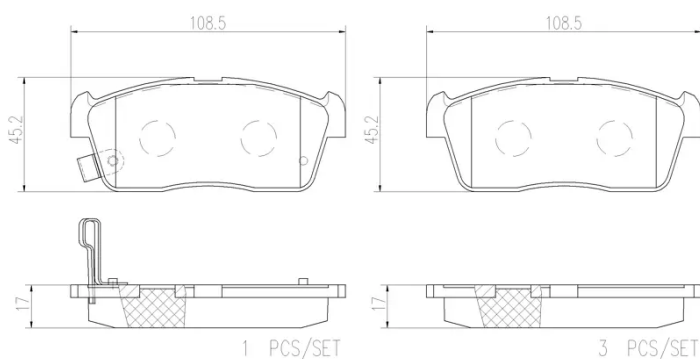

COMPATIBLE VEHICLES

COMPATIBLE OE PART NUMBERS

410604A00B	NISSAN
------------	--------

55810M68K00	SUZUKI
-------------	--------

55810M68K00000	SUZUKI
----------------	--------

55810M68K00L00	SUZUKI
----------------	--------

55810M68K10	SUZUKI
-------------	--------
