



BRAKE PAD

P 28 091

The P 28 091 brake pad is synonymous with reliability

The Brembo brake pad guarantees ultimate safety when braking thanks to the use of more than 100 different compounds, designed according to the type of vehicle and use. Stopping distances reduced to a minimum, maximum driving comfort and silent operation are the most important features of Brembo materials. Brembo brake pads are supplied together with an extensive range of accessories and assembly kits for professional-standard installation.

- ✓ OE-equivalent
- ✓ Brembo quality
- ✓ ECE-R90 certificate
- ✓ Safety
- ✓ Performance
- ✓ Comfort

Technical specifications

EAN code 8020584117057	Axle Rear	Thickness 16 mm
Width 117 mm	Height 48 mm	Braking system TRW
Wear indicator Acoustic	WVA number 22389,22390,22391	Accessories With anti-squeal shim

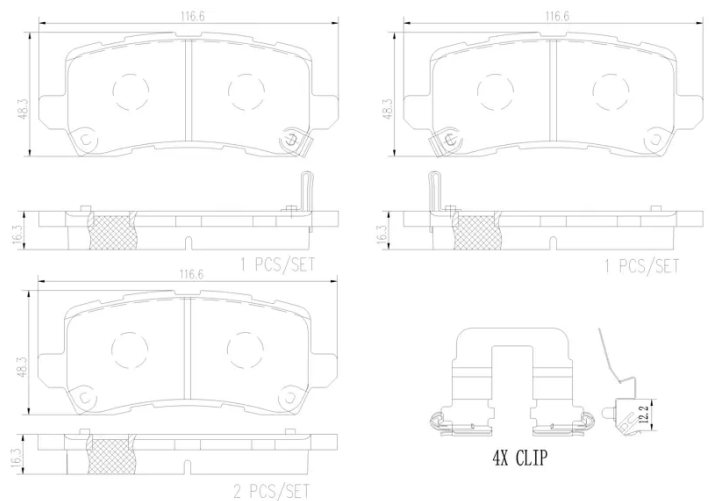

COMPATIBLE VEHICLES

COMPATIBLE OE PART NUMBERS

43022TY2A00	ACURA
-------------	-------

43022TY2A01	ACURA
-------------	-------

43022TZ5H00	ACURA
-------------	-------

43022TZ5H01	ACURA
-------------	-------

43022THRA51	HONDA
-------------	-------

43022TY2A01	HONDA
-------------	-------

43022TY2A02	HONDA
-------------	-------

43022TZ3A51	HONDA
-------------	-------

43022TZ5A10	HONDA
-------------	-------

43022TZ5H00	HONDA
-------------	-------