



BRAKE PAD PRIME CERAMIC P59055N

The P59055N NAO brake pad is synonymous with reliability

Brembo NAO brake pads stand out for their ultimate braking comfort, reduced friction wear and low dust mission, which makes for cleaner rims and reduced maintenance requirements. The advanced friction material in keeping with the strictest environmental standards is the main distinguishing feature of NAO compounds.

- ✓ OE-equivalent
- ✓ Brembo quality
- ✓ Safety
- ✓ Comfort
- ✓ Durability
- ✓ Dust reduction
- ✓ With accessories



Technical specifications

EAN code 8020584081990	Axle Front	Thickness 19 mm
Width 142 mm	Height 67 mm	Braking system Mando
Wear indicator Acoustic	WVA number 24412,24413,24414	Accessories With anti-squeal shim

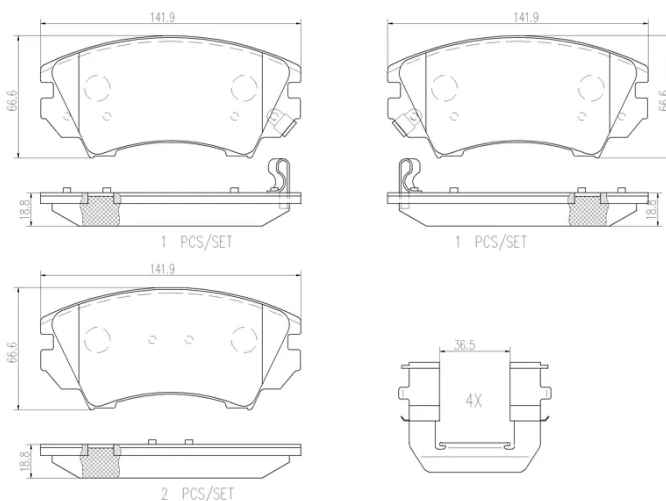

COMPATIBLE VEHICLES

COMPATIBLE OE PART NUMBERS

26292744	BUICK (SGM)
26372717	BUICK (SGM)
9006945	BUICK (SGM)
13237751	CHEVROLET
19421344	CHEVROLET
92230269	CHEVROLET
92257988	CHEVROLET
9006945	CHEVROLET (SGM)
13237751	GENERAL MOTORS
22786292	GMC
13237751	OPEL
1605186	OPEL
1605232	OPEL
1605265	OPEL
1605317	OPEL
1605434	OPEL
1680880480	OPEL
22959104	OPEL
95514526	OPEL
95516195	OPEL
95520061	OPEL
95530018	OPEL
10424274	ROEWE (SAIC)
95516195	VAUXHALL