



BRAKE PAD

P 59 094

The P 59 094 brake pad is synonymous with reliability

The Brembo brake pad guarantees ultimate safety when braking thanks to the use of more than 100 different compounds, designed according to the type of vehicle and use. Stopping distances reduced to a minimum, maximum driving comfort and silent operation are the most important features of Brembo materials. Brembo brake pads are supplied together with an extensive range of accessories and assembly kits for professional-standard installation.

- ✓ OE-equivalent
- ✓ Brembo quality
- ✓ ECE-R90 certificate
- ✓ Safety
- ✓ Performance
- ✓ Comfort



Technical specifications

EAN code	Axle	Thickness
8020584084656	Front	15 mm
Width	Height	Braking system
125 mm	71 mm	Brembo
Wear indicator	WVA number	Accessories
Acoustic	25528,25629,25630	With anti-squeal shim

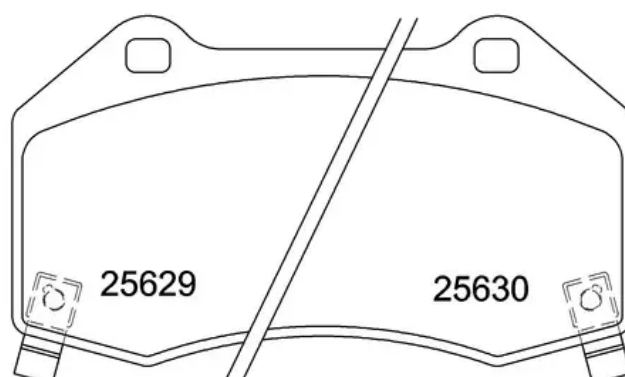
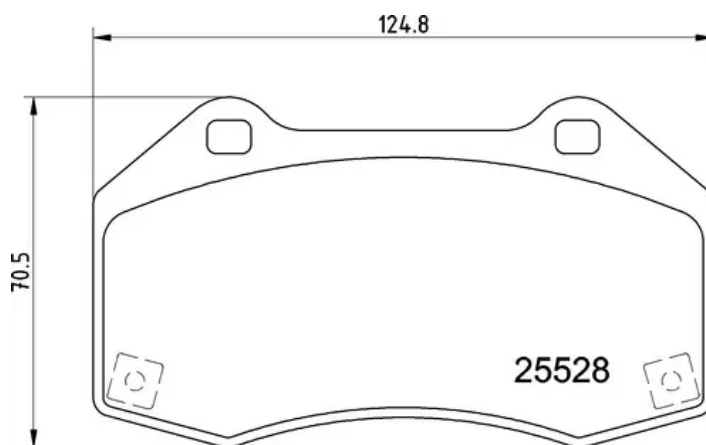

COMPATIBLE OE PART NUMBERS

1605145	OPEL
1605231	OPEL
95509897	OPEL
95515503	OPEL
1605145	VAUXHALL