



SA BRAKE PAD 07KA31SA

The 07KA31SA brake pad is synonymous with reliability

Sintered compound, specific for front application, characterised by excellent efficiency in all conditions of use. It is the ideal alternative to original pads. This compound is characterised by low wear which guarantees long life and suitable mileage.

- ✓ OE-equivalent
- ✓ Brembo quality
- ✓ ECE-R90 certificate
- ✓ Safety
- ✓ Performance
- ✓ Comfort



Technical specifications

Width mm	Height 41,9 mm	Thickness 7,5 mm
Compound Sinter	Units per box 2	

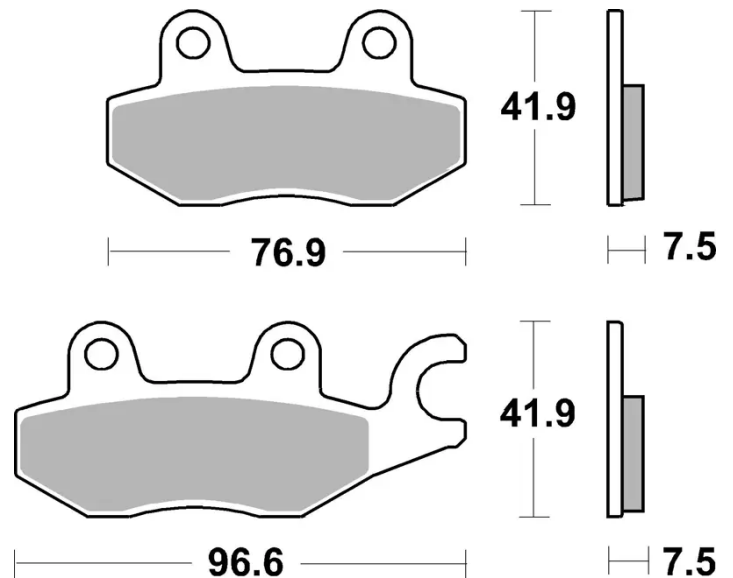

COMPATIBLE VEHICLES