



# BRAKE PAD

## P 83 022

The P 83 022 brake pad is synonymous with reliability

The Brembo brake pad guarantees ultimate safety when braking thanks to the use of more than 100 different compounds, designed according to the type of vehicle and use. Stopping distances reduced to a minimum, maximum driving comfort and silent operation are the most important features of Brembo materials. Brembo brake pads are supplied together with an extensive range of accessories and assembly kits for professional-standard installation.

- ✓ OE-equivalent
- ✓ Brembo quality
- ✓ ECE-R90 certificate
- ✓ Safety
- ✓ Performance
- ✓ Comfort

### Technical specifications

EAN code	Axle	Thickness
<b>8020584057575</b>	<b>Front</b>	<b>13 mm</b>
Width	Height	Braking system
<b>105 mm</b>	<b>46 mm</b>	<b>Akebono</b>
Wear indicator	WVA number	Accessories
<b>Acoustic</b>	<b>21948,21949</b>	<b>With anti-squeal shim</b>

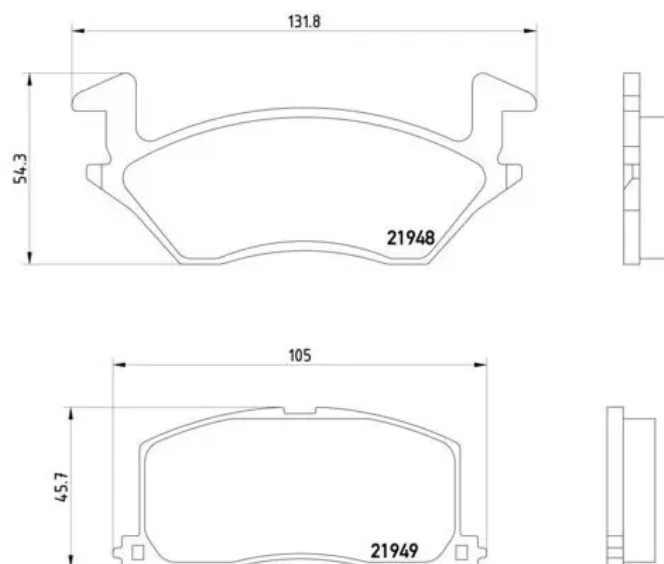

COMPATIBLE VEHICLES

## COMPATIBLE OE PART NUMBERS

AY040TY018	NISSAN
------------	--------

0446510020	TOYOTA
------------	--------

0446510070	TOYOTA
------------	--------

04465YZZAE	TOYOTA
------------	--------

0449110111	TOYOTA
------------	--------

0449110120	TOYOTA
------------	--------

0449110131	TOYOTA
------------	--------

0449110141	TOYOTA
------------	--------