



UPGRADE GT KIT

1N3.8012A_

The 1N3.8012A_ GT kit is synonymous with superior performance

Complete braking systems, comprising components derived from the world of motorsports and offering unrivalled levels of technology on the market. They feature aluminium radial-mounted fixed calipers, with opposing pistons. Depending on the type of system and the required performance level, the calipers can either be in two-parts, monoblock or even monoblock machined from solid billet metal. The uprated brake discs can be integral (one-piece) or composite, drilled or slotted.



- ✓ Brembo quality
- ✓ Safety
- ✓ Performance
- ✓ Comfort
- ✓ Sports driving
- ✓ Sparty look

Available in 4 colours

- 1N3.8012A1
- 1N3.8012A2
- 1N3.8012A3
- 1N3.8012A5

Technical specifications



| | | |
|-----------------|-----------------|------------------|
| Axle | Diameter | Thickness (TH) |
| Front | 350 mm | 34 mm |
| Caliper pistons | Disc type | Caliper type |
| 6 | 2 pieces | Monoblock |

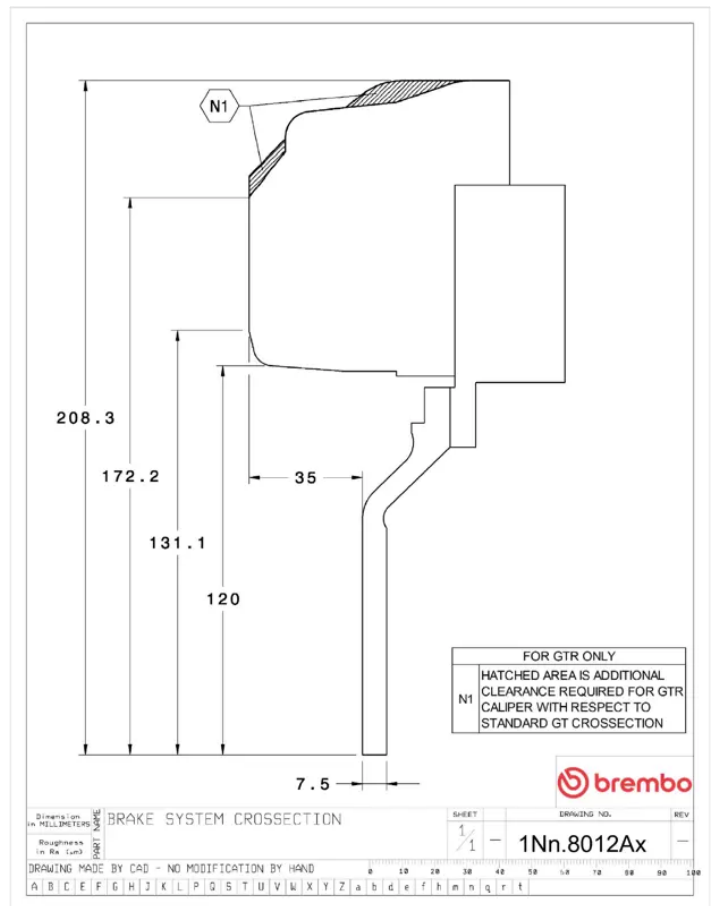

COMPATIBLE VEHICLES