



BRAKE PAD

P 83 083

The P 83 083 brake pad is synonymous with reliability

The Brembo brake pad guarantees ultimate safety when braking thanks to the use of more than 100 different compounds, designed according to the type of vehicle and use. Stopping distances reduced to a minimum, maximum driving comfort and silent operation are the most important features of Brembo materials. Brembo brake pads are supplied together with an extensive range of accessories and assembly kits for professional-standard installation.

- ✓ OE-equivalent
- ✓ Brembo quality
- ✓ ECE-R90 certificate
- ✓ Safety
- ✓ Performance
- ✓ Comfort



Technical specifications

EAN code	Axle	Thickness
8020584062210	Rear	14 mm
Width	Height	Braking system
99 mm	43 mm	Akebono
Wear indicator	WVA number	Accessories
Acoustic	24610,24611,24612	With anti-squeal shim

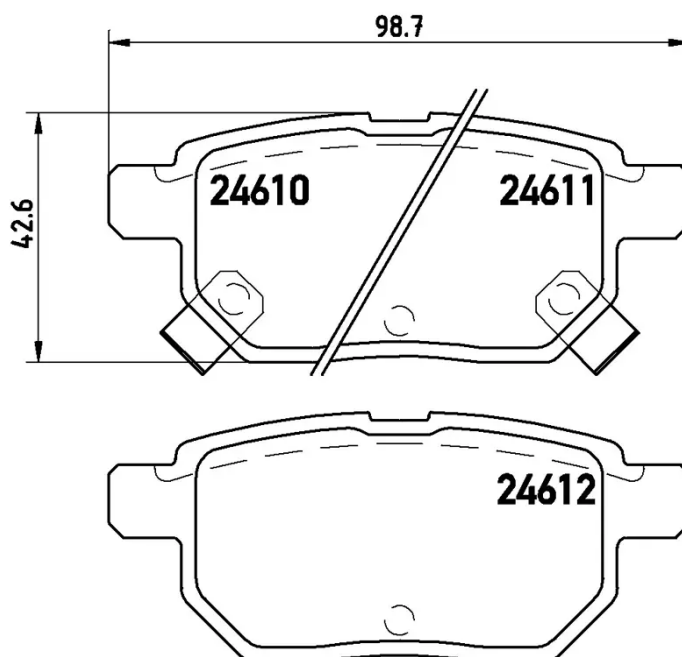

COMPATIBLE OE PART NUMBERS

J696GN3502080

CHERY

3500700X4320F011

JAC

19205632

PONTIAC