



# BRAKE DISC CO-CAST

## 09.D532.13

Co-Cast brake disc 09.D532.13 belongs to Brembo Premium Line

The Co-Cast brake disc consists of a steel hat cast onto the high-carbon cast iron braking surface. This technology not only ensures superior performance for the braking system but also allows the weight of the disc itself to be reduced by up to 15%, resulting in reduced consumption and emission levels and improved road handling.



- ✓ OE-equivalent
- ✓ Brembo quality
- ✓ ECE-R90 certificate
- ✓ Weight reduction
- ✓ High carbon
- ✓ Bi-Material Brake Disc
- ✓ Anti-corrosion
- ✓ PVT ventilation
- ✓ Fastening screws
- ✓ Fading resistance

### Technical specifications

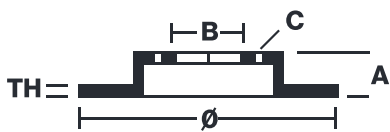

EAN code  
**8020584233764**

Axle  
**Rear**

Diameter Ø  
**360 mm**

Thickness (TH)  
**26 mm**

Height (A)  
**49 mm**

Number of holes (C)  
**5**

Brake disc type  
**Ventilated**

Centering (B)  
**69 mm**

Min. thickness  
**23,4 mm**

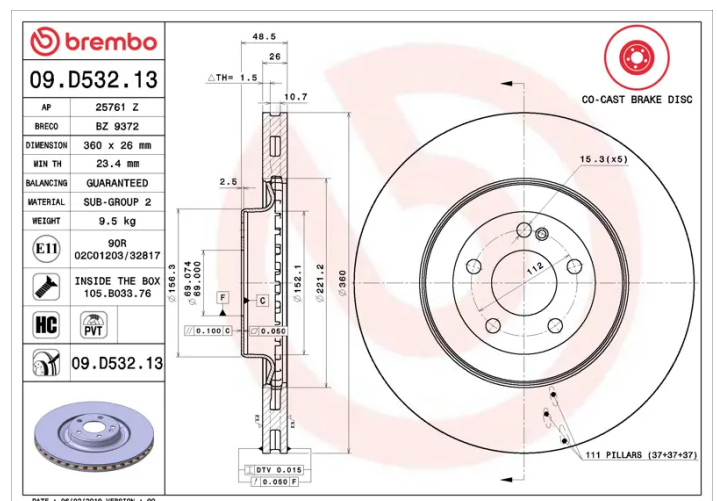

## COMPATIBLE OE PART NUMBERS

0004231712

MERCEDES-BENZ

---

A0004231712

MERCEDES-BENZ

---

A0004231712

MERCEDES-BENZ (BBDC)

---