



BRAKE PAD PRIME CERAMIC P59076N

The P59076N NAO brake pad is synonymous with reliability

Brembo NAO brake pads stand out for their ultimate braking comfort, reduced friction wear and low dust mission, which makes for cleaner rims and reduced maintenance requirements. The advanced friction material in keeping with the strictest environmental standards is the main distinguishing feature of NAO compounds.

- ✓ OE-equivalent
- ✓ Brembo quality
- ✓ Safety
- ✓ Comfort
- ✓ Durability
- ✓ Dust reduction
- ✓ With accessories



Technical specifications

EAN code 8020584082430	Axle Front	Thickness 19 mm
Width 148 mm	Height 61 mm	Braking system Bosch
Wear indicator Acoustic	WVA number 25031,25032,25033	Accessories With anti-squeal shim

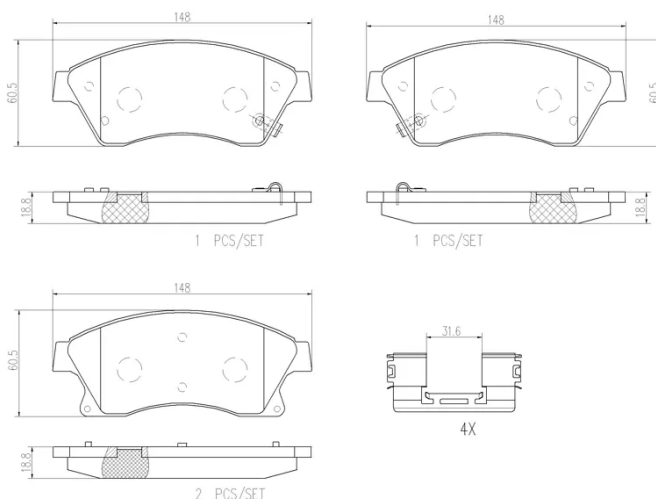

COMPATIBLE VEHICLES

COMPATIBLE OE PART NUMBERS

93723739	BUICK (SGM)
13301207	CHEVROLET
13374966	CHEVROLET
13412272	CHEVROLET
13412807	CHEVROLET
42570931	CHEVROLET
42589333	CHEVROLET
42793253	CHEVROLET
13356286	GENERAL MOTORS
13412807	GENERAL MOTORS
13301207	OPEL
13374966	OPEL
13412272	OPEL
1605169	OPEL
1605261	OPEL
542120	OPEL
95516191	OPEL
95530019	OPEL
13301207	VAUXHALL
542120	VAUXHALL