



BRAKE PAD PRIME CERAMIC P79027N

The P79027N NAO brake pad is synonymous with reliability

Brembo NAO brake pads stand out for their ultimate braking comfort, reduced friction wear and low dust mission, which makes for cleaner rims and reduced maintenance requirements. The advanced friction material in keeping with the strictest environmental standards is the main distinguishing feature of NAO compounds.

- ✓ OE-equivalent
- ✓ Brembo quality
- ✓ Safety
- ✓ Comfort
- ✓ Durability
- ✓ Dust reduction
- ✓ With accessories

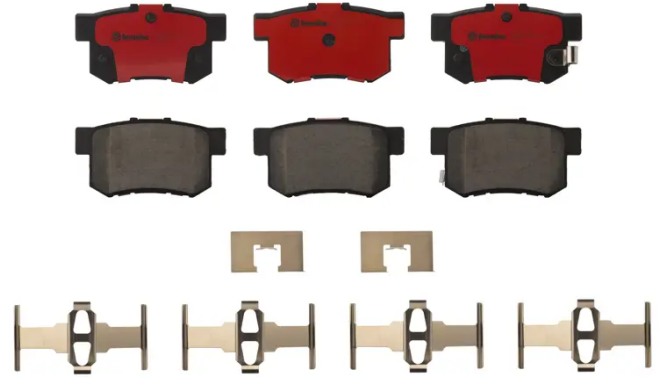

Technical specifications

EAN code 8020584086810	Axle Rear	Thickness 15 mm
Width 89 mm	Height 47 mm	Braking system Akebono
Wear indicator Acoustic	WVA number 21719,21720,25201	Accessories With anti-squeal shim

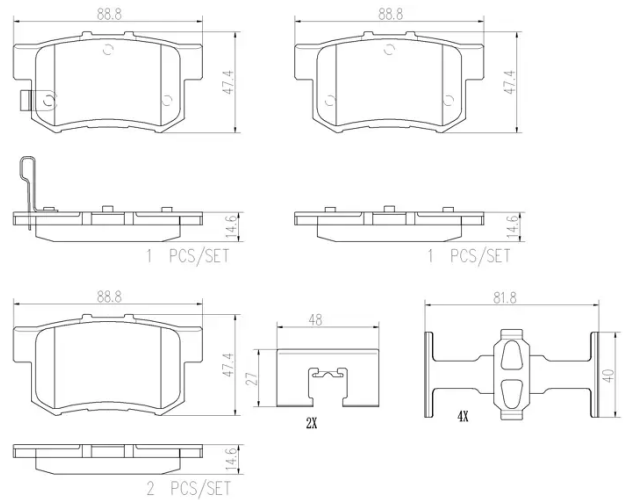

COMPATIBLE VEHICLES

COMPATIBLE OE PART NUMBERS

000071768576 FIAT

600628642 FIAT

71750931 FIAT

71768493 FIAT

71768576 FIAT

0643055AE50 HONDA

4302252A010 HONDA

4302252AE50 HONDA

43022TDJ010 HONDA

5580080J02 SUZUKI

5580080J02000 SUZUKI

5580080J03 SUZUKI

5580080J03000 SUZUKI

5580080J05000 SUZUKI
