



BRAKE PAD PRIME CERAMIC P10054N

The P10054N NAO brake pad is synonymous with reliability

Brembo NAO brake pads stand out for their ultimate braking comfort, reduced friction wear and low dust mission, which makes for cleaner rims and reduced maintenance requirements. The advanced friction material in keeping with the strictest environmental standards is the main distinguishing feature of NAO compounds.

- ✓ OE-equivalent
- ✓ Brembo quality
- ✓ Safety
- ✓ Comfort
- ✓ Durability
- ✓ Dust reduction
- ✓ With accessories



Technical specifications

EAN code 8020584085639	Axle Front	Thickness 18 mm
Width 133 mm	Height 49 mm	Braking system Akebono
Wear indicator Acoustic	WVA number 25268,25269,25270	Accessories With anti-squeal shim

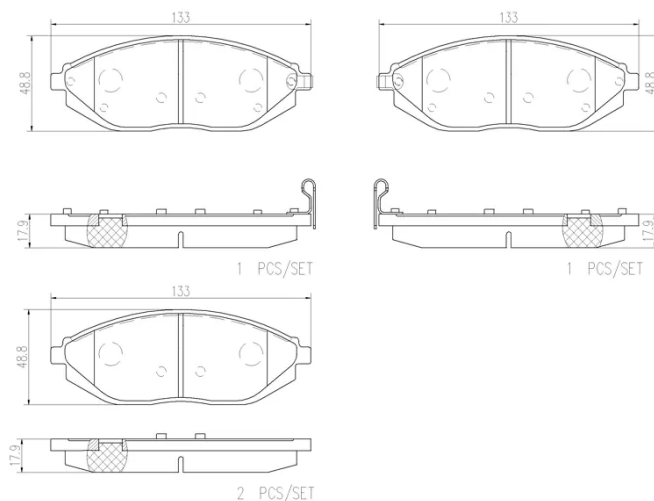

COMPATIBLE VEHICLES

COMPATIBLE OE PART NUMBERS

42785996	CHEVROLET
94564512	CHEVROLET
96682858	CHEVROLET