



BRAKE DISC

09.A047.40

The **09.A047.40** brake disc is synonymous with reliability

The Brembo brake disc is fully interchangeable with an Original Equipment brake disc. The control of the entire production cycle allows Brembo to offer brake discs with outstanding performance levels, reliability, durability and comfort in all conditions of use. All Brembo brake discs are accompanied by the ECE-R90 homologation.

- ✓ OE-equivalent
- ✓ Brembo quality
- ✓ ECE-R90 certificate
- ✓ Safety
- ✓ High carbon
- ✓ PVT ventilation



Technical specifications



EAN code
8020584030493

Axle
Front

Diameter Ø
294 mm

Thickness (TH)
22 mm

Height (A)
44 mm

Number of holes (C)
4

Brake disc type
Ventilated

Centering (B)
64 mm

Min. thickness
20,4 mm

Tightening torque
120 Nm

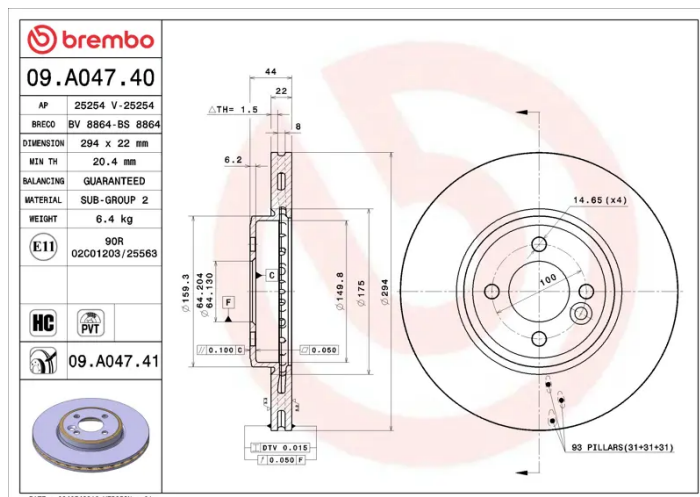

COMPATIBLE VEHICLES

COMPATIBLE OE PART NUMBERS