



BRAKE PAD PRIME CERAMIC P37013N

The P37013N NAO brake pad is synonymous with reliability

Brembo NAO brake pads stand out for their ultimate braking comfort, reduced friction wear and low dust mission, which makes for cleaner rims and reduced maintenance requirements. The advanced friction material in keeping with the strictest environmental standards is the main distinguishing feature of NAO compounds.

- ✓ OE-equivalent
- ✓ Brembo quality
- ✓ Safety
- ✓ Comfort
- ✓ Durability
- ✓ Dust reduction
- ✓ With accessories



Technical specifications

EAN code 8020584098271	Axle Rear	Thickness 14 mm
Width 140 mm	Height 49 mm	Braking system Kelsey Hayes
Wear indicator Without	WVA number 24899,24898,24355	Accessories With accessories With anti-squeal shim With piston clip

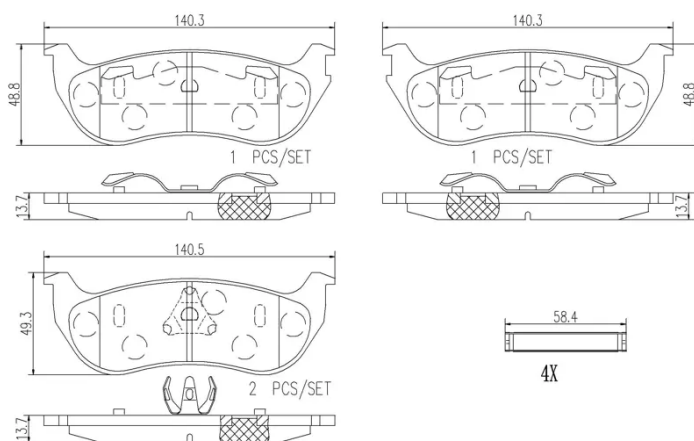

COMPATIBLE VEHICLES

COMPATIBLE OE PART NUMBERS

05083882AD JEEP

05083882AF JEEP

05093511AA JEEP

05093511AB JEEP

05093511AC JEEP

5083882AF JEEP

5093511AA JEEP

5093511AB JEEP

5093511AC JEEP

K05083882AD JEEP

K05083882AF JEEP

K05093511AA JEEP

K05093511AB JEEP

K05093511AC JEEP
