



SP BRAKE PAD 07BB20SP

The 07BB20SP brake pad is synonymous with reliability

Sintered compound, for rear application and stable in all conditions of use.

- ✓ OE-equivalent
- ✓ Brembo quality
- ✓ ECE-R90 certificate
- ✓ Safety
- ✓ Comfort



Technical specifications

Width mm	Height 53,88 mm	Thickness 7,8 mm
Compound Sinter	Units per box 2	

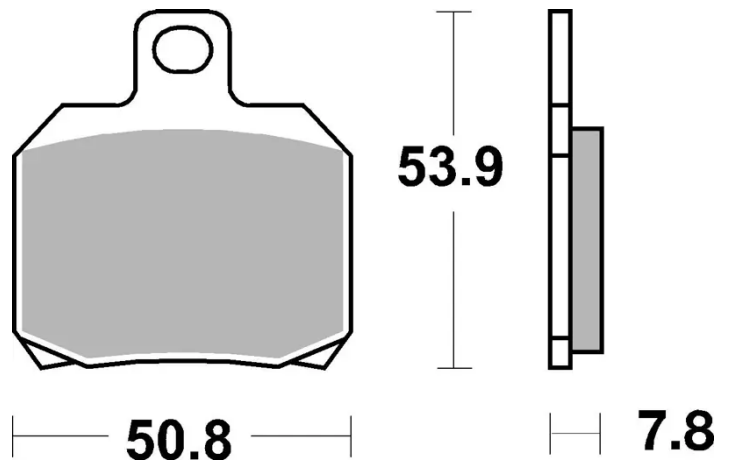

COMPATIBLE VEHICLES