



BRAKE PAD PRIME CERAMIC P30122N

The P30122N NAO brake pad is synonymous with reliability

Brembo NAO brake pads stand out for their ultimate braking comfort, reduced friction wear and low dust mission, which makes for cleaner rims and reduced maintenance requirements. The advanced friction material in keeping with the strictest environmental standards is the main distinguishing feature of NAO compounds.

- ✓ OE-equivalent
- ✓ Brembo quality
- ✓ Safety
- ✓ Comfort
- ✓ Durability
- ✓ Dust reduction
- ✓ With accessories

Technical specifications

EAN code 8020584119181	Axle Front	Thickness 18 mm
Width 133 mm	Height 58 mm	Braking system Mando
Wear indicator Acoustic	WVA number 25348,25349,25350	Accessories With anti-squeal shim

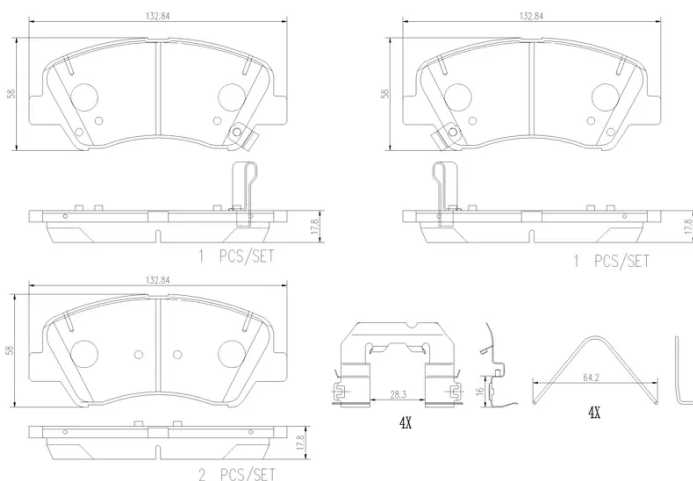

COMPATIBLE VEHICLES

COMPATIBLE OE PART NUMBERS

1014031279	GEELY
4048034500	GEELY
1014031279	GEOMETRY
58101C8A00	HYUNDAI
58101C8A10	HYUNDAI
58101C8A50	HYUNDAI
58101C8A60	HYUNDAI
58101COA00	HYUNDAI
58101H5A25	HYUNDAI
58101H9A60	HYUNDAI
58101Q3A10	HYUNDAI (BEIJING)
58101H8A05	KIA
58101H9A10	KIA