



# UPGRADE GT KIT

## 1N1.9055A\_

The 1N1.9055A\_ GT kit is synonymous with superior performance

Complete braking systems, comprising components derived from the world of motorsports and offering unrivalled levels of technology on the market. They feature aluminium radial-mounted fixed calipers, with opposing pistons. Depending on the type of system and the required performance level, the calipers can either be in two-parts, monoblock or even monoblock machined from solid billet metal. The uprated brake discs can be integral (one-piece) or composite, drilled or slotted.



- ✓ Brembo quality
- ✓ Safety
- ✓ Performance
- ✓ Comfort
- ✓ Sports driving
- ✓ Sparty look

Available in 4 colours

- 1N1.9055A1
- 1N1.9055A2
- 1N1.9055A3
- 1N1.9055A5

## Technical specifications

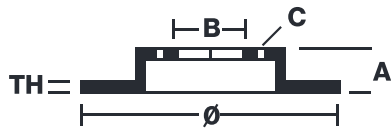

Axle	Diameter	Thickness (TH)
Front	<b>380 mm</b>	<b>34 mm</b>
Caliper pistons	Disc type	Caliper type
<b>6</b>	<b>2 pieces</b>	<b>Monoblock</b>

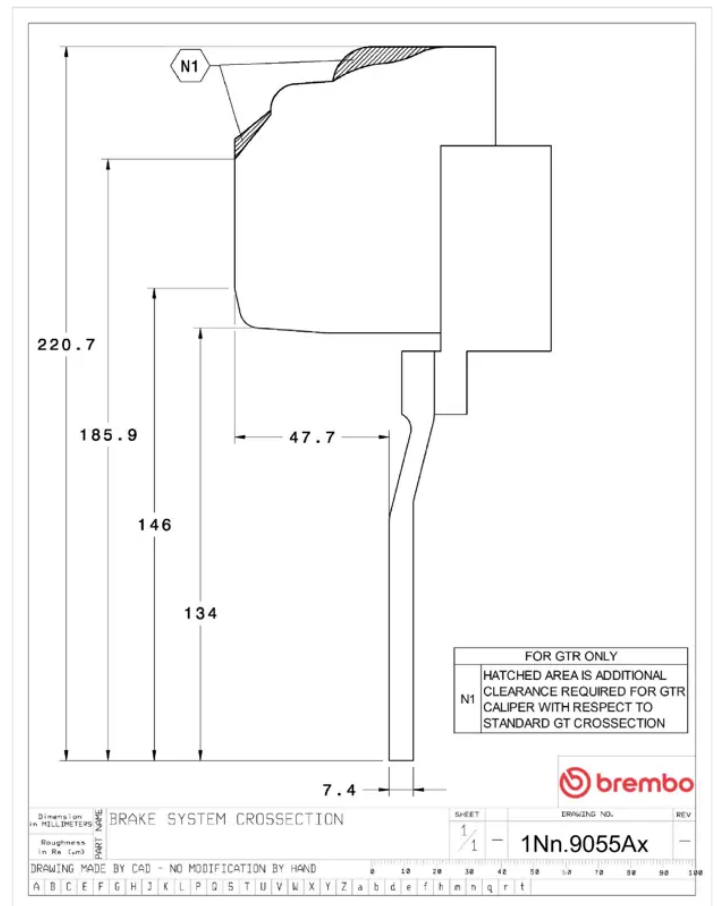

COMPATIBLE VEHICLES