



BRAKE PAD PRIME CERAMIC

P30109N

The P30109N NAO brake pad is synonymous with reliability

Brembo NAO brake pads stand out for their ultimate braking comfort, reduced friction wear and low dust mission, which makes for cleaner rims and reduced maintenance requirements. The advanced friction material in keeping with the strictest environmental standards is the main distinguishing feature of NAO compounds.

- ✓ OE-equivalent
- ✓ Brembo quality
- ✓ Safety
- ✓ Comfort
- ✓ Durability
- ✓ Dust reduction
- ✓ With accessories

Technical specifications

EAN code 8020584118672	Axle Rear	Thickness 16 mm
Width 141 mm	Height 49 mm	
Wear indicator Acoustic	WVA number 22675,22676,22677	Accessories With anti-squeal shim

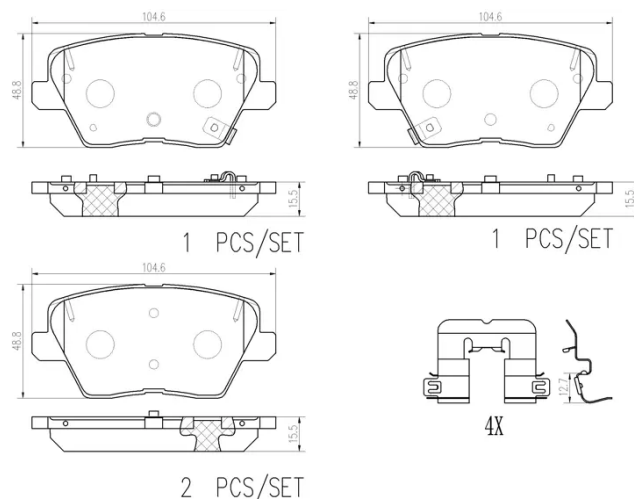

COMPATIBLE VEHICLES

COMPATIBLE OE PART NUMBERS

58302G4A30

HYUNDAI