



SP BRAKE PAD 07BB28SP

The 07BB28SP brake pad is synonymous with reliability

Sintered compound, for rear application and stable in all conditions of use.

- ✓ OE-equivalent
- ✓ Brembo quality
- ✓ ECE-R90 certificate
- ✓ Safety
- ✓ Comfort



Technical specifications

Width mm	Height 36,5 mm	Thickness 8,6 mm
Compound Sinter	Units per box 2	

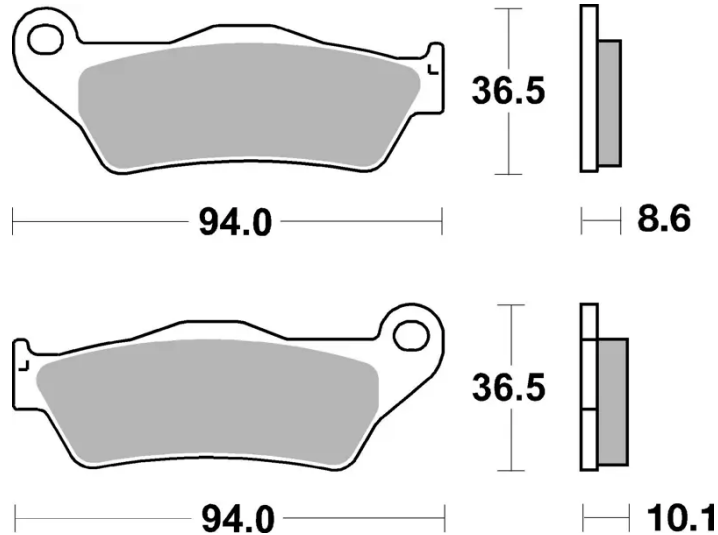

COMPATIBLE VEHICLES