



BRAKE PAD PRIME CERAMIC P83143N

The P83143N NAO brake pad is
synonymous with reliability

Brembo NAO brake pads stand out for their ultimate braking comfort, reduced friction wear and low dust mission, which makes for cleaner rims and reduced maintenance requirements. The advanced friction material in keeping with the strictest environmental standards is the main distinguishing feature of NAO compounds.

- ✓ OE-equivalent
- ✓ Brembo quality
- ✓ Safety
- ✓ Comfort
- ✓ Durability
- ✓ Dust reduction
- ✓ With accessories



Technical specifications

EAN code 8020584104781	Axle Front	Thickness 17 mm
Width 119 mm	Height 68 mm	Braking system Sumitomo
Wear indicator Acoustic	WVA number 21679,21680	Accessories With anti-squeal shim

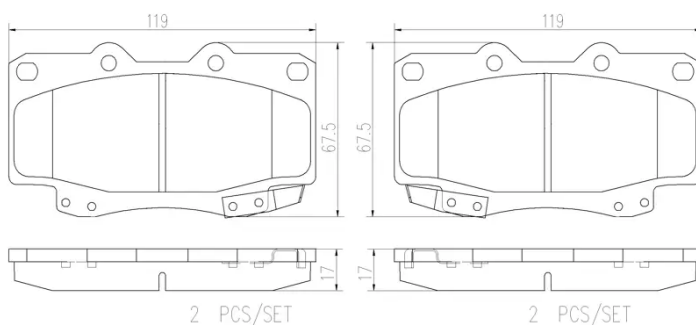

COMPATIBLE VEHICLES